



RAL 7036



RAL 1021



RAL 2009

2 plans / 2 sections

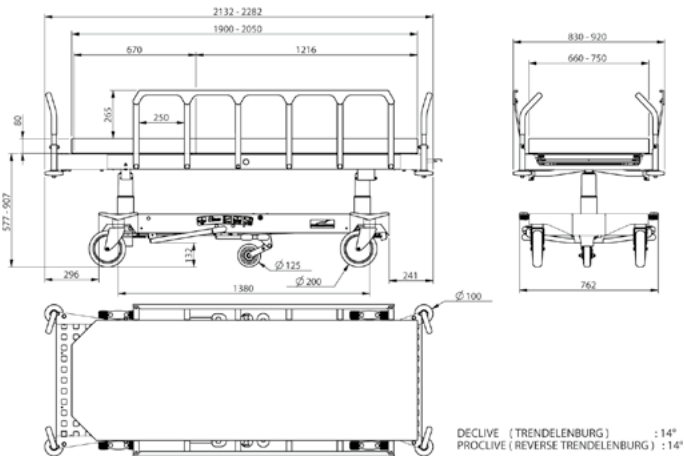

4 plans / 4 sections

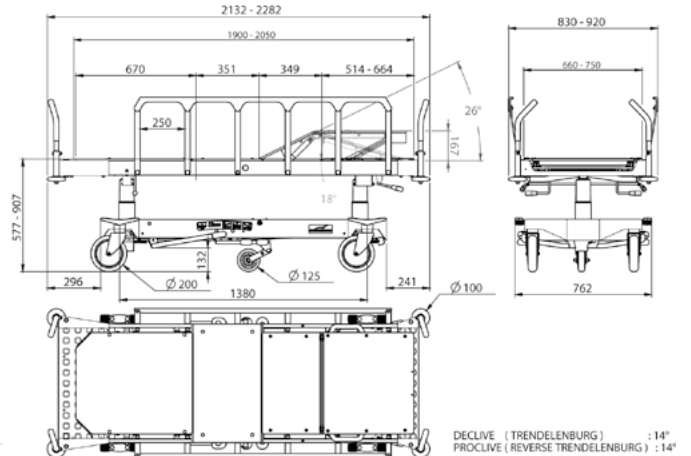

FE-28/14

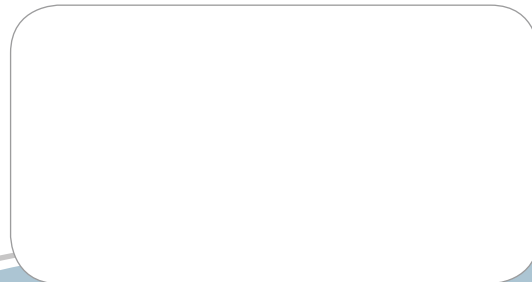



BRANCARD D'URGENCE  
À HAUTEUR VARIABLE  
ADJUSTABLE HEIGHT  
EMERGENCY STRETCHER

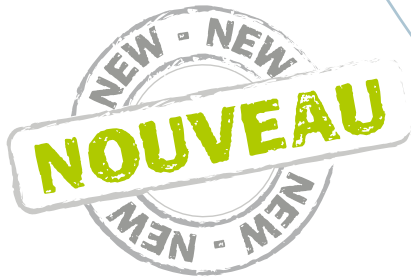

# *Elineo*

*Emergency*



Version : 07-2014



Accessibility • Comfort • Safety

# Elineo

Ultra maniable, modulable, personnalisable et résistant, le nouveau brancard ELINEO urgence facilite la vie des professionnels de santé tout en maximisant le confort et la sécurité du patient !

Extremely manoeuvrable, modular, customisable and resistant, the new ELINEO emergency stretcher makes life easier for health professionals, while maximising patient comfort and safety!

## CONFORT / COMFORT

- Ultra maniable : grande facilité de déplacement
- Disponible en 2 ou 4 plans
- Mise en place des barrières facile et sécurisée
- Plan de couchage disponible en 4 dimensions et en 2 épaisseurs de matelas
- Poignées de poussée intégrées en standard côté tête et côté pieds
- Possibilité de personnaliser la couleur du brancard pour faciliter son identification
- 5<sup>e</sup> roue et roues roll + incluses en standard permettant de réduire les efforts de poussée
- Plan en résine radio transparent
- Extremely manoeuvrable
- Available in 2 or 4 section versions
- Easy and secure installation of the side rails
  - Bed surface available in 4 sizes and 2 mattress thicknesses
  - Push bars at the head and foot ends as standard
  - Colors can be customized to facilitate identification
  - 5th castor and roll + castors as standard for easier pushing
  - X ray transparent resin base

## ACCESSIBILITÉ ACCESSIBILITY

- Hauteur variable de 58 à 91 cm\*
- Commandes d'élévation faciles à manipuler des 2 côtés du brancard
- Espace de rangement intégré sous le dossier
- Grand espace de rangement sous le plan de couchage, en ABS ou inox (en accessoire)
- Variable height from 58 to 91 cm\*
  - Easy-to-use elevation controls on both sides of the stretcher
    - Integrated storage space under the back rest
    - Large storage space under the bed base, in ABS or stainless steel (optional accessory)

\* Hauteur sans matelas / Height without mattress



\*Sans matelas / Without mattress



Modèle présenté  
avec options/accessoires  
Version presented  
with options/accessories

## SÉCURITÉ / SAFETY

- Capacité de charge jusqu'à 250 kg
- Procline / Déclive accessible par commandes bilatérales
- Freinage centralisé aux 4 coins du brancard
- Barrières verticales 6 barreaux en inox
- Load capacity of up to 250 kg
- Trendelenburg / Reverse trendelenburg tilt accessible by bilateral controls
  - Centralized braking at the 4 corners of the stretcher
    - 6-bar vertical rails in stainless steel

## HYGIÈNE / HYGIENE

- Matelas amovible, étanche et anti-allergique
- Structure simple sans aspérité et facile à nettoyer
- Carter de protection ou panier inox amovible et facilement démontable sans outils (en accessoire)
- Barrières en acier inoxydable
- Waterproof, anti-allergy removable mattress
- Simple structure with easy-to-clean smooth surface
  - Detachable oxygen bottle holder base that can easily be removed without tools (accessory)
  - Stainless steel side rails



Position basse  
Low position



Transfert  
Transfer



Procline  
Trendelenburg



Déclive  
Reverse trendelenburg



Position haute  
High position

## CARACTÉRISTIQUES STANDARD

Hauteur variable de 58 à 91 cm (sans matelas)  
 Procline / Décline accessible par commandes bilatérales  
 Structure acier revêtement époxy polyester gris nuage  
 Plan dur en résine radio transparent compatible C-arm  
 4 roues roll ø 200 mm avec freinage centralisé  
 5<sup>e</sup> roue directionnelle  
 Dossier relevable par double vérin à gaz  
 4 pare-chocs latéraux  
 4 supports accessoires  
 Poignées de poussée repliables côté tête et côté pieds  
 Poids maximum du patient autorisé 250 kg  
 Compatibilité Bed mover  
**Matelas à choisir séparément**

## STANDARD FEATURES

Height adjustable from 58 to 91 cm (without mattress)  
 Trendelenburg / Reverse trendelenburg tilt accessible by bilateral controls  
 Steel structure gray cloud epoxy polyester coating  
 X-ray transparent resin bed base C-arm compatible  
 4 castors ø 200 mm with centralized braking  
 Fifth steering castor  
 Dual gas cylinder adjustable backrest  
 4 lateral protective bumpers  
 4 accessory supports  
 Foldable push bars at head and foot ends  
 Maximum patient weight : 250 kg  
 Bed mover compatible  
**Mattress to be chosen separately**

		2 plans / 2 sections				4 plans / 4 sections			
		16245-10M	16245-10L	16745-10M	16745-10L	16245-20M	16245-20L	16745-20M	16745-20L
Longueur / Length	190 cm	●	●			●	●		
Longueur / Length	205 cm			●	●			●	●
Largeur / Width	66 cm	●		●		●		●	
Largeur / Width	75 cm		●		●		●		●

### Options\*

\* A demander impérativement lors de la commande, montage usine / To be requested at the time of order for factory mounting

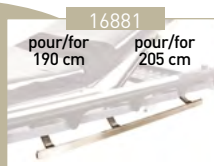

16881  
 pour/for 190 cm    pour/for 205 cm  
 Paire de rails latéraux en bout côté tête  
 Pair of head end side rails



16878  
 Paire de rails latéraux côté pied  
 Pair of foot end side rails

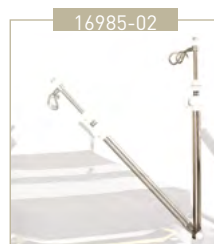

16985-02  
 Tige porte-sérum télescopique repliable 2 crochets  
 Folding telescopic IV shaft support

Couleurs des barrières - A préciser à la commande  
 Rail color - To be defined at the time of order

RAL 5000

RAL 1021

RAL 2009

### Accessoires Accessories

Accroche velcro : préciser « S » après votre référence matelas / Velcro attachment : indicate «S» after mattress reference number



19066-08 66 x 190 cm  
 66 x 205 cm 20566-08  
 Épaisseur matelas / Mattress thickness  
**8 cm**



19066-12 66 x 190 cm  
 66 x 205 cm 20566-12  
 Épaisseur matelas / Mattress thickness  
**12 cm**



25190-01 66 x 190 cm    25205-01 66 x 205 cm  
 Matelas de transfert 50 mm, housse PVC bleue  
 50mm transfer mattress, blue PVC cover



2985-01  
 Tige porte-sérum autobloquant 2 crochets  
 Auto-locking 2 hook IV shaft

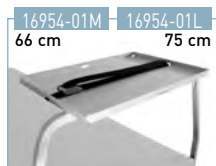

16954-01M 66 cm    16954-01L 75 cm  
 Tablette support monitoring  
 Monitor support tray



16950-01M 66 cm    16950-01L 75 cm  
 Porte-rouleau réglable  
 Adjustable paper-roll holder (350-750 mm)

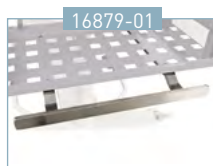

16879-01  
 Rail côté tête  
 Head end rail

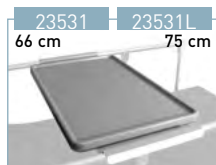

23531 66 cm    23531L 75 cm  
 Tablette repas  
 Dining tray



159040-01  
 Carter amovible porte-bouteille oxygène (dim. D, E, F)  
 Removable oxygen bottle holder (dim. D, E, F)

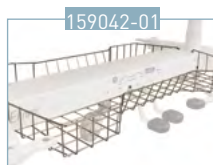

159042-01  
 Panier de rangement latéral en inox (G ou D)  
 Lateral stainless steel basket (L or R)