



BRANCARD DE TRANSFERT
À HAUTEUR VARIABLE
VARIABLE-HEIGHT
TRANSFER STRETCHER



Elineo



Elineo

Maniable, modulable, sécurisé, facile d'usage et offrant un confort optimal pour vos patients, ELINEO, le nouveau brancard de transfert vous apporte les fonctions essentielles dont vous avez vraiment besoin !

The new ELINEO transfer stretcher fulfils all the essential functions that you really need. It is easy to manoeuvre, safe, easy to use and keeps your patients perfectly comfortable.

CONFORT / COMFORT

- Ultra maniable : grande facilité de déplacement
- Mise en place des barrières facile et sécurisée
- Barres de poussée disponibles en standard côté tête et côté pied
- Plan de couchage disponible en 4 dimensions et en 2 épaisseurs de matelas (selon version)
- 5^e roue nouvelle génération pour une meilleure adhérence et efficacité (en option)
- Compatible bed mover*
- Ergonomic cotsides ensure easy operation
- Easy and secure installation of the side rails
- Push bars at the head and foot ends come as standard
- Various mattresses available to suit customers requirements
 - New-generation fifth castor for better grip and improved performance (option)
 - compatible with most bed movers*

ACCESSIBILITÉ ACCESSIBILITY

- Hauteur variable de 57 à 90 cm**
- Commandes d'élévation faciles à manipuler des 2 côtés du brancard
- Grand espace de rangement sous le plan de couchage (en accessoire)
- Variable height from 57 to 90 cm*
- Easy-to-use elevation controls on both sides of the stretcher
- Large storage facility within the optional oxygen cylinder holder base

** Hauteur sans matelas / Height without mattress

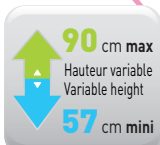

Modèle présenté
avec options/accessoires
Product shown
with options/accessories

SÉCURITÉ / SAFETY

- Capacité de charge jusqu'à 250 kg
- Proclive / Déclive accessible par commandes bilatérales
- Freinage centralisé aux 4 coins du brancard
- Barrières verticales en inox
- Compatible barrières pédiatriques
- Load capacity of up to 250 kg
- Trendelenburg / Reverse Trendelenburg controls on both sides
 - Centralised brakes at the four corners of the stretcher
 - Stainless steel robust cotsides
 - Compatible with paediatric siderails

HYGIÈNE / HYGIENE

- Matelas amovible, étanche et antiallergique
- Structure simple sans aspérité et facile à nettoyer
- Carter de protection amovible et facilement démontable sans outils (en accessoire)
- Barrières en acier inoxydable
- Waterproof, anti-allergy mattress
- Simple structure without any protruding parts and easy to clean
- Detachable oxygen bottle holder base that can be removed without any tools (accessory)
 - Stainless Steel cotsides



Position basse
Low position



Transfert
Transfer



Proclive
Reverse trendelenburg



Déclive
Trendelenburg



Position haute
High position

CARACTÉRISTIQUES STANDARD

Hauteur variable de 57 à 90 cm (sans matelas)
 Procline / Décline accessible par commandes bilatérales
 Structure acier revêtement époxy polyester gris nuage
 Plan dur en résine radio transparent compatible C-arm
 4 roues ø 200 mm avec freinage centralisé,
 dont 2 directionnelles côté tête (commande aux 4 coins)
 Dossier relevable par double vérin à gaz
 4 pare-chocs latéraux + bandes de protection latérale
 4 supports accessoires
 Barrières repliables sous le niveau de couchage
 Poignées de poussée
 Poids maximum du patient autorisé 250 kg
Livré sans matelas

STANDARD FEATURES

Variable height from 57 to 90 cm (without mattress)
 Trendelenburg / Reverse Trendelenburg controls on both sides
 Polyester epoxy-coated steel structure, cloud grey
 X-ray translucent resin mattress base, C-arm compatible
 Four ø 200 mm castors with centralised braking, two steering castors
 at the head end (controls on all four corners)
 Dual gas actuator adjustable backrest
 Four corner bumpers and protective bumpers along the sides
 Four accessory sockets
 The Cotsides fold away neatly beside the mattress
 Push handles
 Patient weight capacity: 250 kg
Various mattress options available to suit specific requirements

Modèles Models	Longueur Length 190 cm	Longueur Length 205 cm	Largeur Width 66 cm	Largeur Width 75 cm
15245-10M	●		●	
15245-10L	●			●
15745-10M		●	●	
15745-10L		●		●

Options*

* A demander impérativement lors de la commande, montage usine / Plant installed, must be ordered with initial order



5^e roue directionnelle
Fifth steering castor



1 jeu de 2 roues
antistatiques
One set of two anti-static
castors



Roulettes « Roll+ »
« Roll+ » castors



Poignées repliables
côté tête
Folding handles
at the head end



Poignées repliables côté pied
(incompatible avec le
porte-dossier patient)
Folding handles at the foot end
(not compatible with the patient
notes holder)

Accessoires Accessories

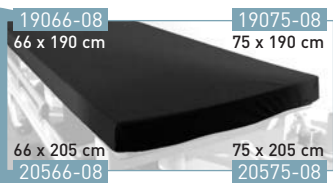

Épaisseur matelas / Mattress thickness
8 cm

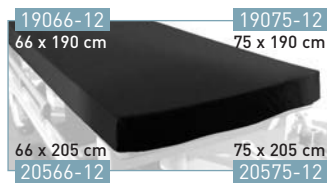

Épaisseur matelas / Mattress thickness
12 cm



Matelas de transfert
50 mm, housse PVC bleue
50mm transfer mattress,
blue PVC cover



Tige porte-sérum
autobloquant 2 crochets
Auto-locking 2 hook IV pole

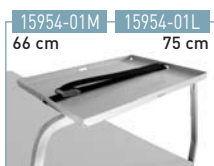

Tablette support
monitoring
Monitor support tray



Porte-rouleau réglable
Adjustable paper-roll holder
(350-750 mm)

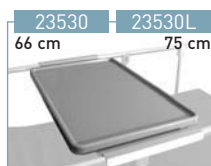

Tablette repas
Dining tray



Paire de protections
pédiatriques pour barrières
Pair of padded cotside
bumpers



Porte-dossier patient
incompatible avec les
poignées repliables côté pied
Réf. 15956-01
Patient notes holder
incompatible with the folding
handles at the foot end
Ref. 15956-01



Cartier amovible
porte-bouteille oxygène
(dim. D, E, F)
Removable oxygen bottle
holder base (dim. D, E, F)

Couleurs de matelas
non-feu M1 - Antibactérien
Mattress colors
of M1 fire retardant upholstery
antibacterial

Matelas soudé
Welded mattress

NOIR / BLACK

MARINE / MARINE



15245-10M
+ 19066-08

Poids net
Net weight
99 kg*

Poids brut
Gross weight
147 kg*

Volume
1,45 m³

* Poids « nu » :
sans matelas,
sans carter, sans tige
porte-sérum.
Version : 66 x 190 cm

* Weight when bare:
without the mattress,
housing and IV pole.
Version: 66 x 190 cm

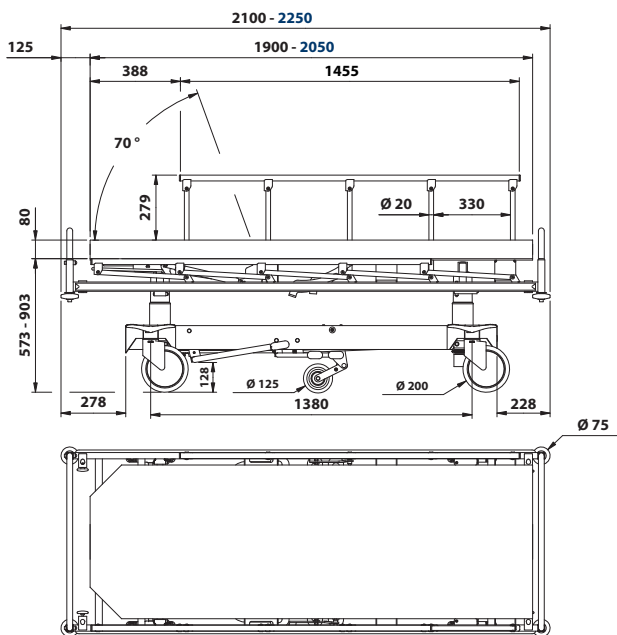

Largeur 66 cm
Width 66 cm

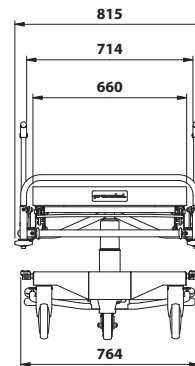

Largeur 75 cm
Width 75 cm

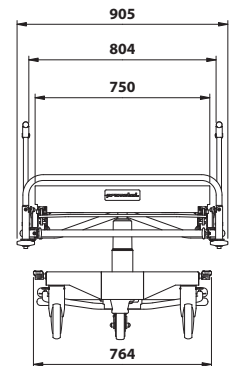

Proctive / décline : 14°
Trendelenburg / reverse trendelenburg: 14°

G007/FE-51/11

Midmark Europe SAS
22, rue de Saint-Denis - 53500 Ernée
www.promotal.com

